

120V N-Ch Power MOSFET
Feature

- ◇ High Speed Power Switching, Logic Level
- ◇ Enhanced Body diode dv/dt capability
- ◇ Enhanced Avalanche Ruggedness
- ◇ 100% UIS Tested, 100% Rg Tested
- ◇ Lead Free, Halogen Free

V_{DS}		120	V
$R_{DS(on),typ}$	$V_{GS}=10V$	7.9	m Ω
$R_{DS(on),typ}$	$V_{GS}=4.5V$	9.5	m Ω
I_D (Silicon Limited)		44	A

Application

- ◇ Synchronous Rectification in SMPS
- ◇ Hard Switching and High Speed Circuit
- ◇ DC/DC in Telecoms and Industrial

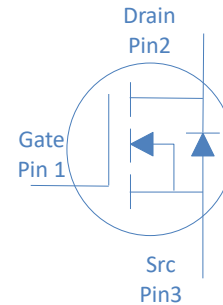
TO-220F

Part Number	Package	Marking
HGA093N12SL	TO-220F	GA093N12SL

Absolute Maximum Ratings at $T_J=25^\circ\text{C}$ (unless otherwise specified)

Parameter	Symbol	Conditions	Value	Unit
Continuous Drain Current (Silicon Limited)	I_D	$T_C=25^\circ\text{C}$	44	A
		$T_C=100^\circ\text{C}$	31	
Drain to Source Voltage	V_{DS}	-	120	V
Gate to Source Voltage	V_{GS}	-	± 20	V
Pulsed Drain Current	I_{DM}	-	250	A
Avalanche Energy, Single Pulse	E_{AS}	$L=0.1\text{mH}, T_C=25^\circ\text{C}$	101	mJ
Power Dissipation	P_D	$T_C=25^\circ\text{C}$	41	W
Operating and Storage Temperature	T_J, T_{stg}	-	-55 to 175	$^\circ\text{C}$

Absolute Maximum Ratings

Parameter	Symbol	Max	Unit
Thermal Resistance Junction-Ambient	$R_{\theta JA}$	65	$^\circ\text{C}/\text{W}$
Thermal Resistance Junction-Case	$R_{\theta JC}$	3.63	$^\circ\text{C}/\text{W}$

Electrical Characteristics at $T_j=25^{\circ}\text{C}$ (unless otherwise specified)
Static Characteristics

Parameter	Symbol	Conditions	Value			Unit
			min	typ	max	
Drain to Source Breakdown Voltage	$V_{(BR)DSS}$	$V_{GS}=0V, I_D=250\mu A$	120	-	-	V
Gate Threshold Voltage	$V_{GS(th)}$	$V_{GS}=V_{DS}, I_D=250\mu A$	1.4	2	2.4	
Zero Gate Voltage Drain Current	I_{DSS}	$V_{GS}=0V, V_{DS}=120V, T_j=25^{\circ}\text{C}$	-	-	1	μA
		$V_{GS}=0V, V_{DS}=120V, T_j=100^{\circ}\text{C}$	-	-	100	
Gate to Source Leakage Current	I_{GSS}	$V_{GS}=\pm 20V, V_{DS}=0V$	-	-	± 100	nA
Drain to Source on Resistance	$R_{DS(on)}$	$V_{GS}=10V, I_D=20A$	-	7.9	9.3	m Ω
		$V_{GS}=4.5V, I_D=10A$	-	9.5	12.5	
Transconductance	g_{fs}	$V_{DS}=5V, I_D=20A$	-	70	-	S
Gate Resistance	R_G	$V_{GS}=0V, V_{DS}$ Open, $f=1\text{MHz}$	-	1	-	Ω

Dynamic Characteristics

Input Capacitance	C_{iss}	$V_{GS}=0V, V_{DS}=60V, f=1\text{MHz}$	-	2626	-	pF
Output Capacitance	C_{oss}		-	329	-	
Reverse Transfer Capacitance	C_{rss}		-	11	-	
Total Gate Charge	$Q_g(10V)$	$V_{DD}=60V, I_D=20A, V_{GS}=10V$	-	38	-	nC
Total Gate Charge	$Q_g(4.5V)$		-	18	-	
Gate to Source Charge	Q_{gs}		-	7	-	
Gate to Drain (Miller) Charge	Q_{gd}		-	5	-	
Turn on Delay Time	$t_{d(on)}$	$V_{DD}=60V, I_D=20A, V_{GS}=10V, R_G=10\Omega,$	-	13	-	ns
Rise time	t_r		-	7	-	
Turn off Delay Time	$t_{d(off)}$		-	22	-	
Fall Time	t_f		-	9	-	

Reverse Diode Characteristics

Diode Forward Voltage	V_{SD}	$V_{GS}=0V, I_F=20A$	-	0.9	1.2	V
Reverse Recovery Time	t_{rr}	$V_R=60V, I_F=20A, dI_F/dt=100A/\mu s$	-	53	-	ns
Reverse Recovery Charge	Q_{rr}		-	58	-	nC

Fig 1. Typical Output Characteristics

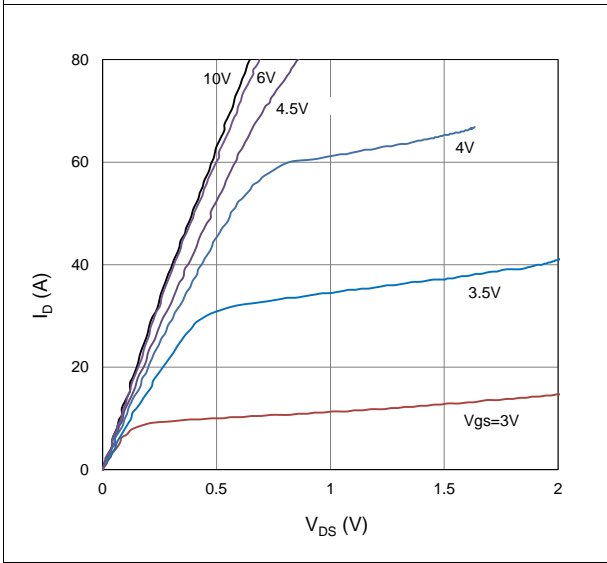

Figure 2. On-Resistance vs. Gate-Source Voltage

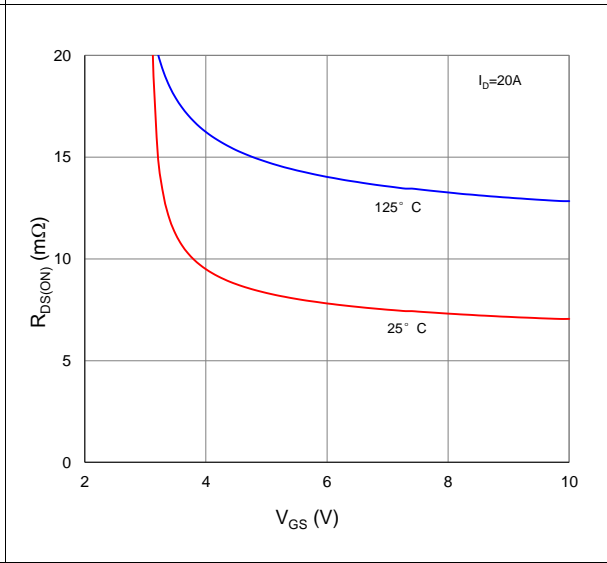

Figure 3. On-Resistance vs. Drain Current and Gate Voltage

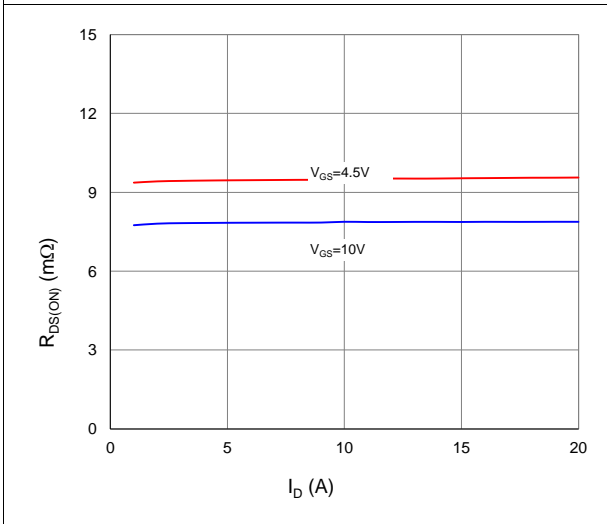

Figure 4. Normalized On-Resistance vs. Junction Temperature

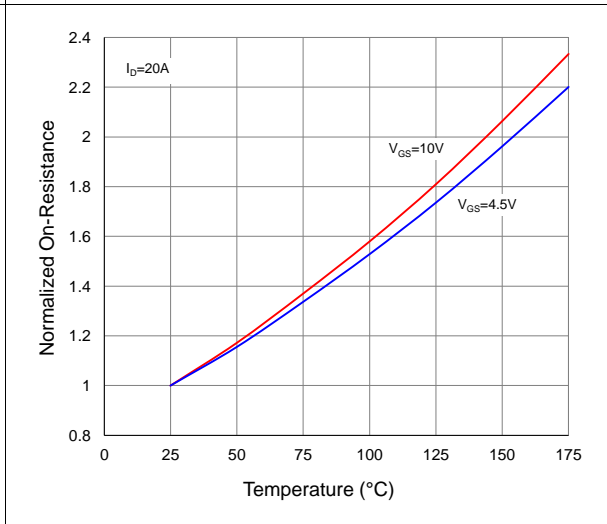

Figure 5. Typical Transfer Characteristics

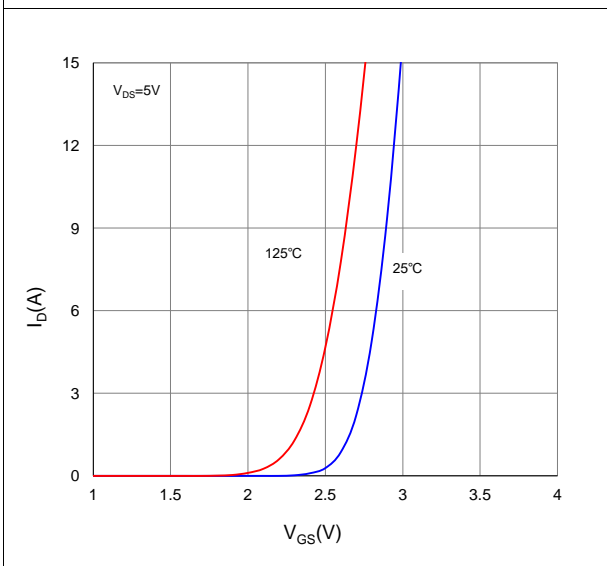

Figure 6. Typical Source-Drain Diode Forward Voltage

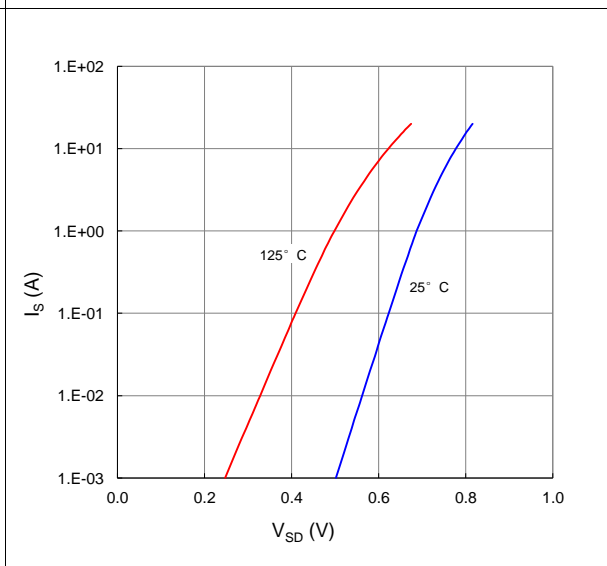

Figure 7. Typical Gate-Charge vs. Gate-to-Source Voltage

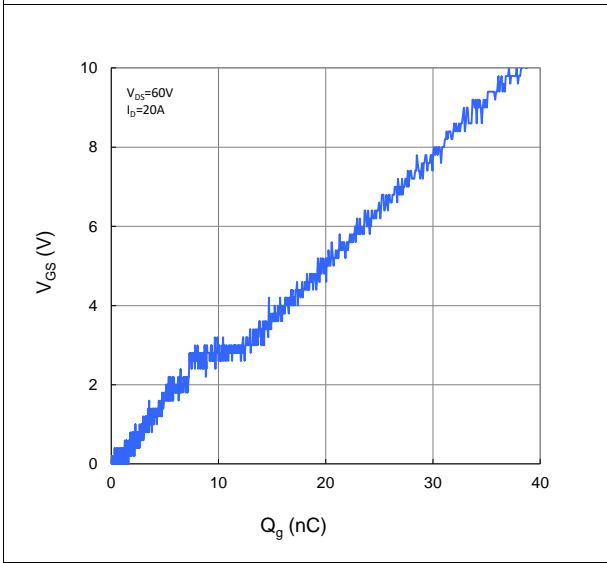

Figure 8. Typical Capacitance vs. Drain-to-Source Voltage

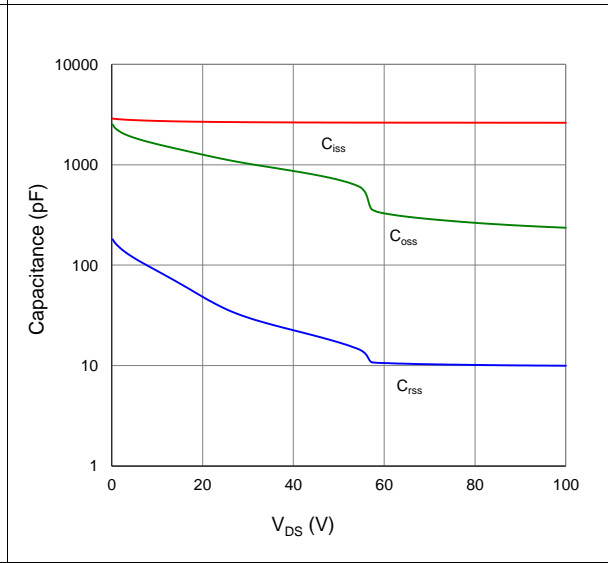

Figure 9. Maximum Safe Operating Area

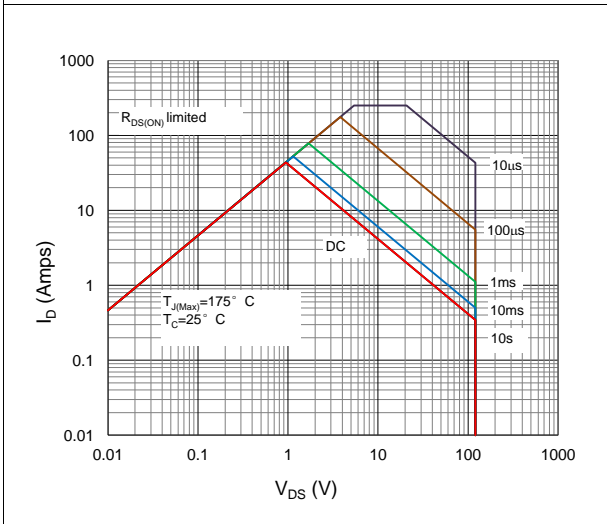

Figure 10. Maximum Drain Current vs. Case Temperature

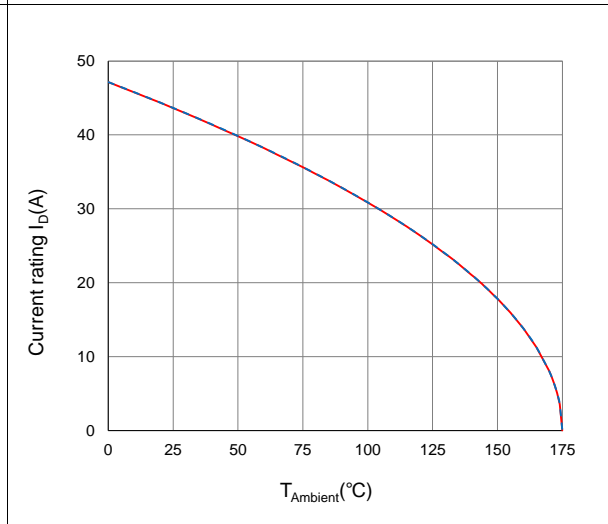
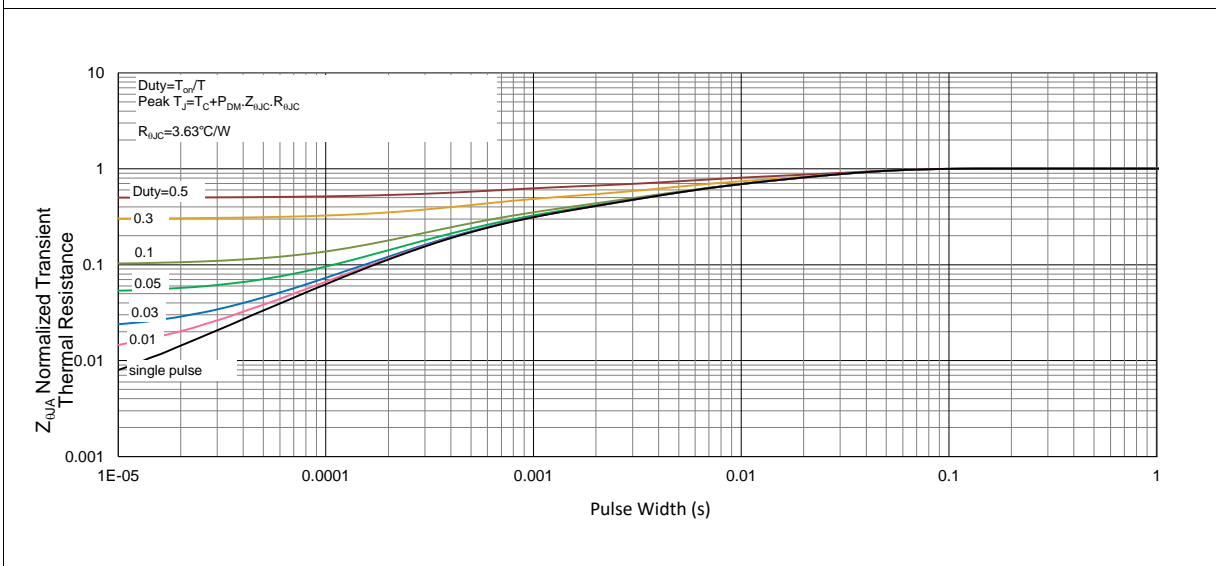
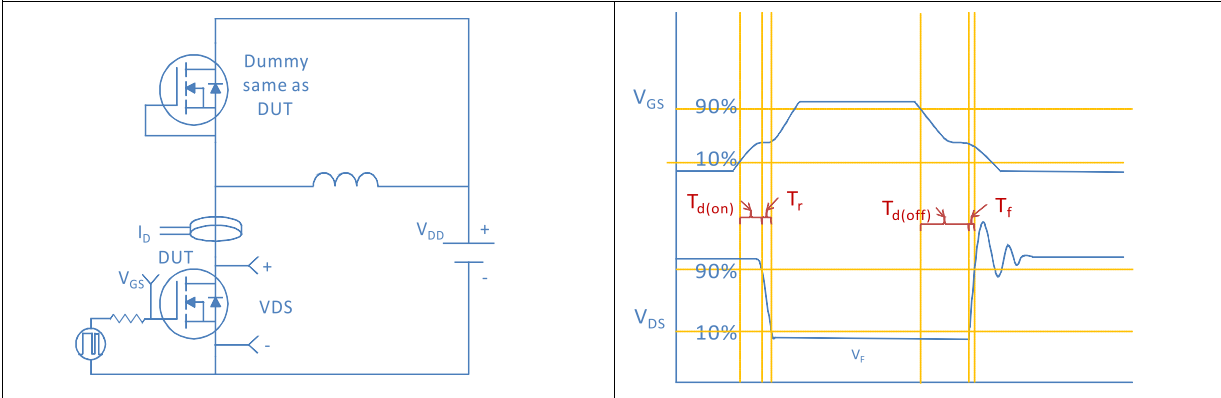

Figure 11. Normalized Maximum Transient Thermal Impedance, Junction-to-Ambient



Inductive switching Test



Gate Charge Test

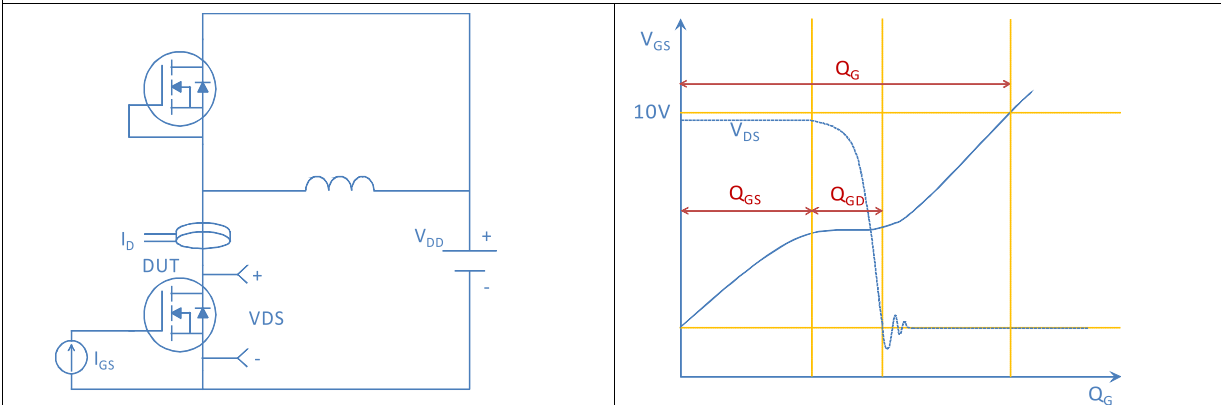

Uclamped Inductive Switching (UIS) Test

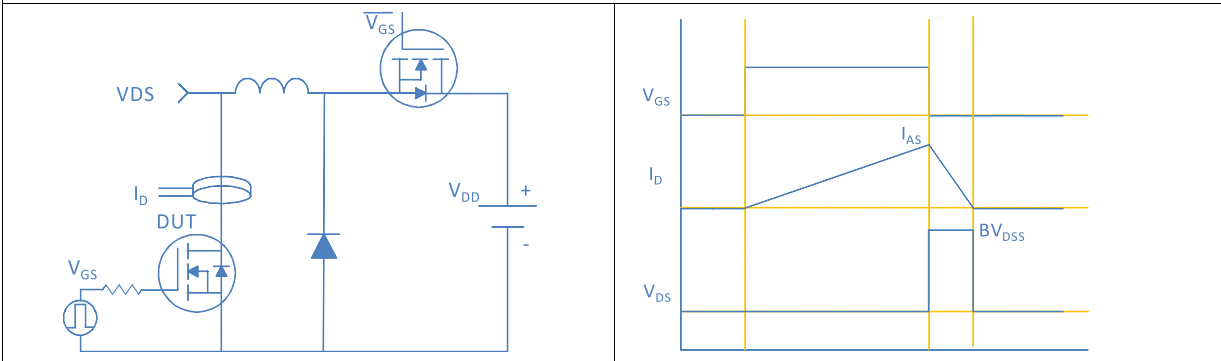

Diode Recovery Test

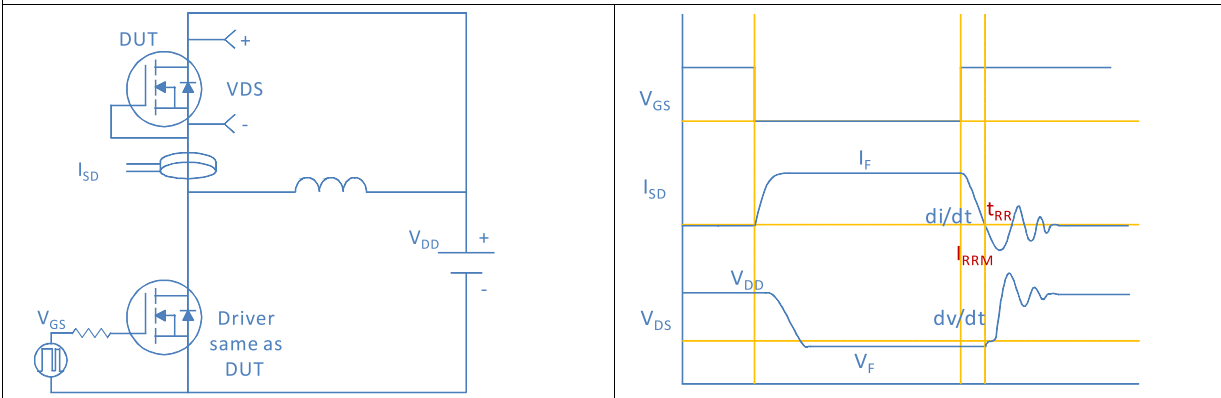

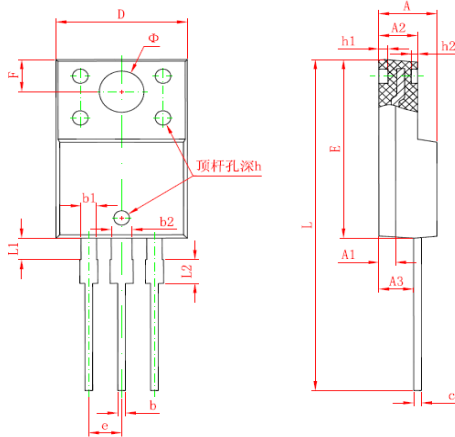
Package Outline
TO-220F, 3 leads

Symbol	Dimensions in Millimeters		Dimensions in Inches	
	Min.	Max.	Min.	Max.
A	4.300	4.700	0.169	0.185
A1	1.300 REF.		0.051 REF.	
A2	2.800	3.200	0.110	0.126
A3	2.500	2.900	0.098	0.114
b	0.500	0.750	0.020	0.030
b1	1.100	1.350	0.043	0.053
b2	1.500	1.750	0.059	0.069
c	0.500	0.750	0.020	0.030
D	9.960	10.360	0.392	0.408
E	14.800	15.200	0.583	0.598
e	2.540 TYP.		0.100 TYP.	
F	2.700 REF.		0.106 REF.	
Φ	3.500 REF.		0.138 REF.	
h	0.000	0.300	0.000	0.012
h1	0.800 REF.		0.031 REF.	
h2	0.500 REF.		0.020 REF.	
L	28.000	28.400	1.102	1.118
L1	1.700	1.900	0.067	0.075
L2	1.900	2.100	0.075	0.083